

AURORA

User' Manual

AS680SB

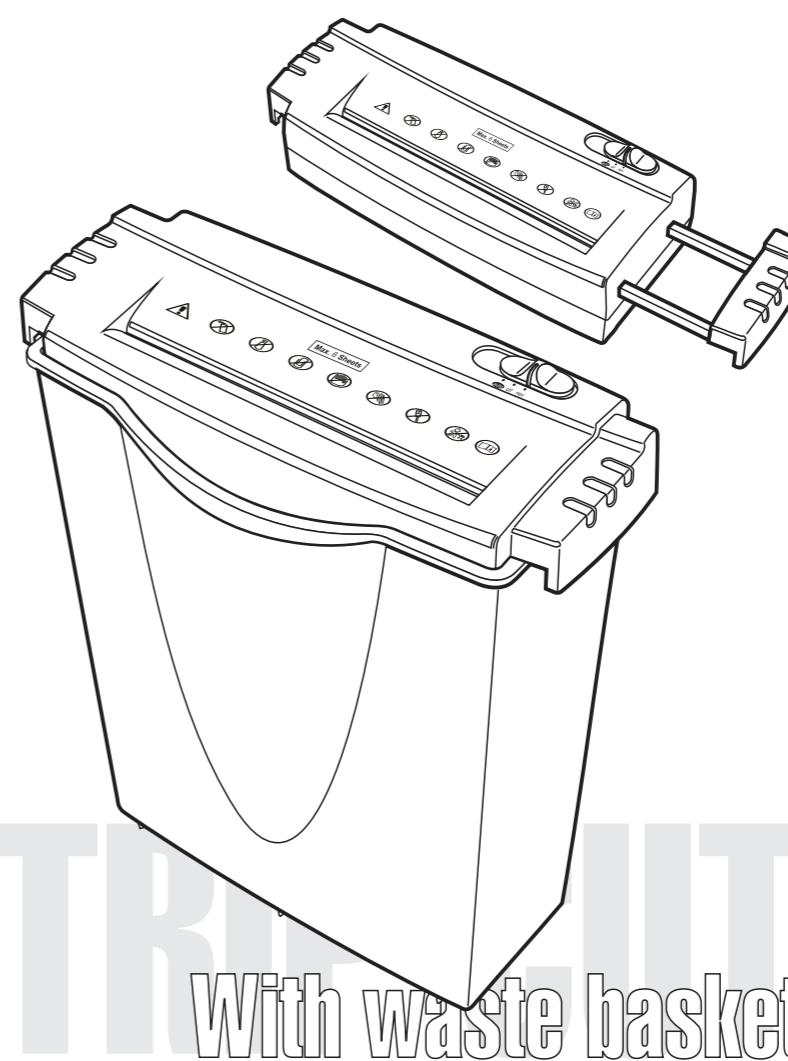

AURORA

Aurora Office Equipment Co.,Ltd.Shanghai
No.388 jiaxin Road,jiaoding District,Shanghai
Tel:(021)59164588 Zip:201818
Http:www.aurora.com.cn

991283753Q

AS680SB User's Manual

Thank you for purchasing Strip-Cut paper shredder of the AS680SB Series. This product is ideal for home/personal and office use with its advanced function and design. This paper shredder will satisfy all your requirements for confidential and safe document disposal. Please read this manual carefully and keep it properly to ensure maintenance service of your paper shredder for one year.

■Operational Instruction

- 1.Install the unit head on the bin, and Connect the shredder with power source in accordance with the power specification indicated on the back of unit.
- 2.Set the switch to "Auto" , the machine is at the stand-by mode. If putting the paper in the insertion slot, the machine will start up automatically and restore to the standby mode the process is complete.
- 3.You had better insert at most 6 sheets of 75g dry paper per time in order to keep it running well and prolong its service life. If the inserted paper is too much, the motor will stop rotating because of its interlock mechanism. Then you'd better decrease the number of paper and restore to shred.
- 4.The machine will stop working if it goes on working over 2 minutes, or has worked on and off for a long time. It is intended to preset temperature protection. After having a rest (about 15 minutes), the machine can work normally again.
- 5.If too much inserted paper has jammed the motor, or you need to withdraw the paper immediately at the normal runtime, please set the switch to "Reverse" , then the motor will rotate in the reverse and back out the unbroken paper.
- 6.If you want to clean the bin, or not to use the machine for a long time, please set the switch to " stop " and cut off the power.
- 7.At the ending of the normal work, the machine may go on working. The main reason is that: the scrap in the bin is too full and then touch the automatic lever. At that time. You should empty the bin, or compact the scrap paper in the bin.
- 8.One sheet of thin, soft, or humid paper may be unable to start the machine, or stop the machine during work, please fold the paper and shred it again.
- 9.Please don not insert clips or fabrics, in case the blades are damaged and the performance of the machine is weakened.







■Attentions

- 1.Please read the user manual carefully before use.
- 2.Please be aware of the safety alert label on the cover of shredder, be sure to ensure human body safety by preventing tie, jewelry or hair from being placed into the machine.
- 3.Please put the machine near the socket.
- 4.Please don't put the machine near the heat sources, or in the humid environment, for a long time.
- 5.Please be sure to cut off the power when you cleaning or repairing this machine.
- 6.Please keep the machine far away from the children and pets.
- 7.The Max. Shredding capacity will be changing according to temperature and humidity in the operating environment.

■Main performance parameters.

Model : **AS680SB**
Shred type: Strip cut
Cut size(mm): 6 mm
Capacity: 6 sheet (75 g/A4)
Speed: ≥ 3 m/min
Throat Width (mm):.....220
Waste Volume (L):.....14
Unit Size (mm):..... 330*155*376
Net Weight(kg):.....2
Main Feature:..... Overheat Protection/Auto Start and Stop

⚠ Important safety notes

-  Please read the instruction manual before using the shredder.
-  Do not spray or keep any aerosol products in or around shredder.
-  Avoid touching the document feed opening with hands.
-  Avoid loose clothing or jewelry touching the document feed opening.
-  Product is not intended for use by children. (product is not a toy).
-  Avoid getting hair near the document feed opening.
-  Do not insert foreign objects into the document feed opening.